

REVISION HISTORY

REV	DATE	DESCRIPTION	DRAWN BY

# 54" x 48" HERITAGE REAR INLINE CAB

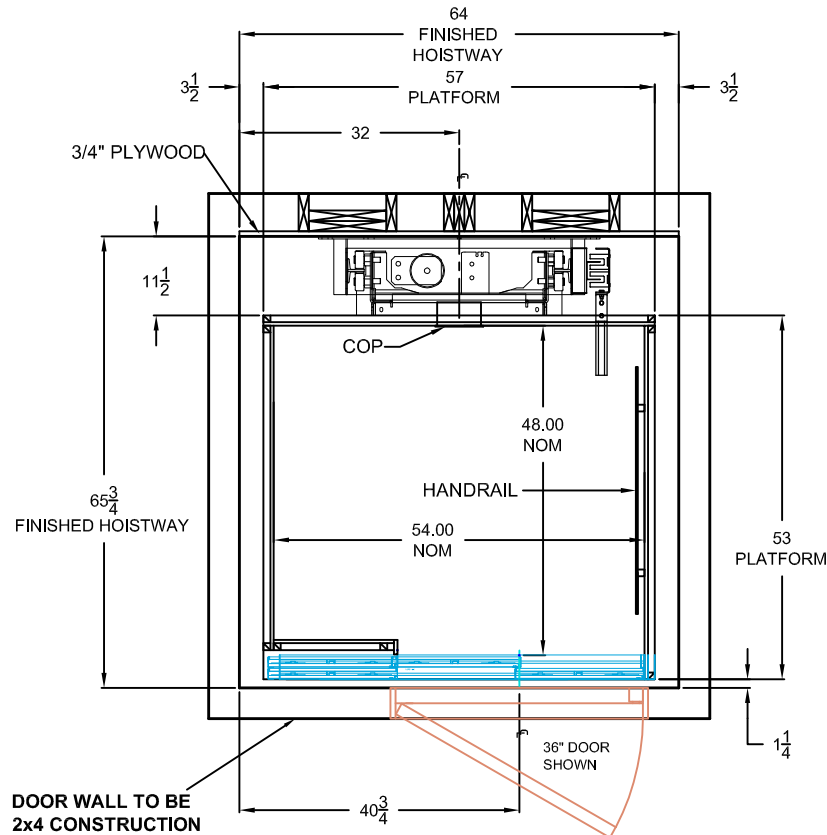

**SPECIFICATIONS**

ROPED 1:2 HYDRAULIC DRIVE SYSTEM.  
 GALVANIZED AIRCRAFT CABLE  
 2 X 3/8" ø 7 X 19 CONSTRUCTION  
 BREAKING LOAD: 14,388 LBS (64.0 KN)  
 OLS 70MM OR 90MM HYDRAULIC CYLINDER  
 OPTICAL LEVELING SYSTEM  
 SLACK ROPE MACHINED SAFETY BLOCK WITH  
 INTEGRATED SAFETY SWITCH  
 ROLLER GUIDE SLING  
 2-SPEED 4 COIL VALVE POWER UNIT (SOFT  
 START & STOP AT EACH LANDING)  
 1" MANUAL SHUT-OFF VALVE, LOW PRESSURE  
 SWITCH, & LINE RUPTURE VALVE  
 0.20 M/S (40 FPM) TRAVEL SPEED-NOMINAL  
 3/4/5 HP POWER UNIT WITH SUBMERSED  
 MOTOR FOR QUIET OPERATION  
 L.E.D. DUAL COLOR ILLUMINATED PUSH  
 BUTTONS IN CAR OPERATING PANEL & HALL  
 CALLS  
 CAR OPERATING PANEL WITH INCORPORATED  
 DIGITAL POSITION INDICATOR, PHONE BOX, &  
 PHONE  
 AUTOMATIC ONE TOUCH CONTROLS  
 BATTERY BACK-UP FOR EMERGENCY  
 LOWERING AND DOOR OPENING

**PROVISIONS BY OTHERS**

- 1) INTERIOR SURFACE OF HOISTWAY MUST BE PLUMB FROM THE BOTTOM TO THE TOP OF THE HOISTWAY WITHIN 1/8"
- 2) MACHINE ROOM AND HOISTWAY TO MEET REQUIREMENTS OF LOCAL CODES
- 3) ELECTRICAL CONTRACTOR TO SUPPLY ONE DEDICATED CIRCUIT GROUND INCLUDED CABLE TO POWER UNIT LOCATION
- 4) ELECTRICAL CONTRACTOR TO SUPPLY DEDICATED 120 VAC SINGLE PHASE 15 AMP SERVICE TO A LOCKABLE FUSED DISCONNECT ON CONTROL PANEL FOR CAB LIGHTING
- 5) PROVIDE CONNECTION TO OUTSIDE PHONE LINE FOR INTEGRATION INTO CAMBRIDGE ELEVATING CONTROLLER (PHONE LINE ALREADY IN ELEVATOR TRAVEL CABLE)
- 6) PROVIDE APPROPRIATE SLEEVES FOR BOTH ELECTRICAL CONDUIT AND HYDRAULIC LINE FROM DRIVE UNIT TO HOISTWAY
- 7) ONLY ELEVATOR MECHANICAL EQUIPMENT OR WIRING TO BE IN THE HOISTWAY
- 8) SUITABLE LINTELS OVER LANDING ENTRANCES ARE TO BE PROVIDED
- 9) PROVIDE PIT WATER PROOFING OR SUMP PUMP IF NECESSARY
- 10) SOLID CORE LANDING DOORS PROVIDED BY OTHERS

**PRODUCTION APPROVALS**

THIS DRAWING REFLECTS OUR INTERPRETATION OF THE INFORMATION THAT WAS PROVIDED ON THIS PRODUCT'S ORDER FORM AND EXACT ELEVATOR SITE MEASUREMENTS THIS INFORMATION IS YOUR RESPONSIBILITY AND IS THE BASIS FROM WHICH THE CUSTOM APPLICATION DESIGN IS DERIVED. PLEASE INDICATE YOUR REQUESTED ACTION BY CHECKING ONE OF THE BELOW BOXES AND SIGNING BELOW TO AUTHORIZE COMPLETION OF THIS ORDER.

- APPROVED WITH NO EXCEPTIONS. MANUFACTURE THIS ELEVATOR PER INFORMATION ON THIS DRAWING
- APPROVED AS NOTED. MAKE CHANGES AS NOTED BEFORE MANUFACTURE. NO RE-APPROVAL REQUIRED
- CHANGES AND REAPPROVAL REQUIRED

SIGNATURE:

PRINT NAME:

DATE:

**DRAWING NOTES**

CAMBRIDGE ELEVATING'S RECOMMENDED MINIMUM HOISTWAY REQUIREMENTS LAYOUT DRAWING FOR HOISTWAY CONSTRUCTION ONLY FINAL CAB LAYOUT MAY VARY ALTHOUGH THE ELEVATOR IS DESIGNED TO MEET CSA-B44/ ANSI A17.1. LOCAL CODES MAY VARY. DEALER IS RESPONSIBLE FOR COMPLYING WITH LOCAL CODES CAMBRIDGE ELEVATING INC. IS NOT RESPONSIBLE FOR THE STRUCTURAL DESIGN OF THE BUILDING AND ITS ABILITY TO SUPPORT THE ELEVATOR LOADS AND/OR REACTIONS CAMBRIDGE ELEVATING INC. RESERVES THE RIGHT TO ALTER EQUIPMENT & HOISTWAY REQUIREMENTS WITHOUT NOTICE



WWW.CAMBRIDGEELEVATING.COM  
 1261 INDUSTRIAL ROAD  
 CAMBRIDGE, ONTARIO, CANADA  
 800.265.3579 519.653.4222

HOISTWAY PLAN VIEW				
DEALER NAME:				
JOB NAME:				
JOB NO:		ISSUE	A	
DATE:		DRAWN BY		SCALE N/A